

SCHEMATIC

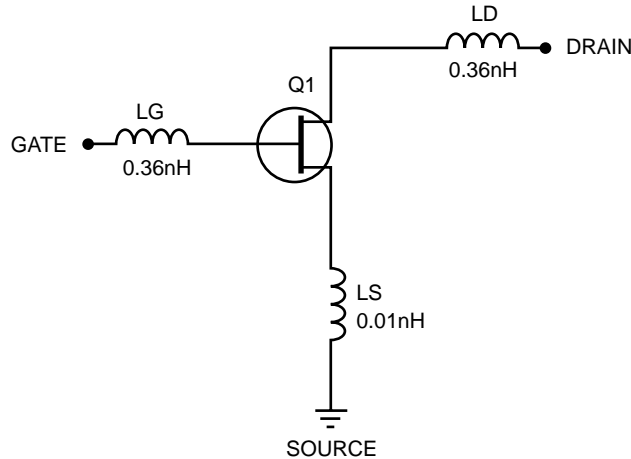

FET NONLINEAR MODEL PARAMETERS ⁽¹⁾

Parameters	Q1	Parameters	Q1
VTO	-2.04	RG	6
VTOSC	0	RD	2
ALPHA	2.5	RS	2
BETA	0.03145	RGMET	0
GAMMA	0.115	KF	0
GAMMADC	0.06	AF	1
Q	1.7	TNOM	27
DELTA	0.42	XTI	3
VBI	1	EG	1.43
IS	7.3e-12	VTOTC	0
N	1.2	BETATCE	0
RIS	0	FFE	1
RID	0		
TAU	6e-12		
CDS	0.15e-12		
RDB	2000		
CBS	1e-9		
CGSO	0.55e-12		
CGDO	0.04e-12		
DELTA1	0.3		
DELTA2	0.2		
FC	0.5		
VBR	Infinity		

UNITS

Parameter	Units
time	seconds
capacitance	farads
inductance	henries
resistance	ohms
voltage	volts
current	amps

MODEL RANGE

Frequency: 0.5 to 20 GHz
 Bias: $V_{ds} = 2\text{ V to }4\text{ V}$, $I_d = 10\text{ mA to }30\text{ mA}$
 Date: 2/10/97

(1) Series IV Libra TOM Model